



**NEC's 6-PIN DIP
400 V BREAK DOWN VOLTAGE
1-CH OPTICAL COUPLED MOS FET**

**PS7142-1A
PS7142L-1A**

FEATURES

- **1 CHANNEL TYPE:**
1 a Output
- **LOW LED OPERATING CURRENT:**
 $I_F = 2\text{mA}$
- **DESIGNED FOR AC/DC SWITCHING LINE CHANGER**
- **SMALL PACKAGE:**
6-Pin DIP
- **LOW OFFSET VOLTAGE**
- **PS7142L-1A:**
Surface mount type
- **SAFETY STANDARDS:**
UL approved: File No. E72422 (S)
BSI approved: File No. 8245/8246
CSA approved: File No. CA 101391

DESCRIPTION

NEC's PS7142-1A and PS7142L-1A are solid state relays containing GaAs LEDs on the light emitting side (input side) and MOS FETs on the output side.

They are suitable for analog signal control because of their low offset and high linearity.

The PS7142L-1A has a surface mount type lead.

APPLICATION

- **Exchange Equipment**
- **Measurement Equipment**
- **FA/OA Equipment**

PACKAGE DIMENSIONS (UNIT: mm)

PS7142-1A

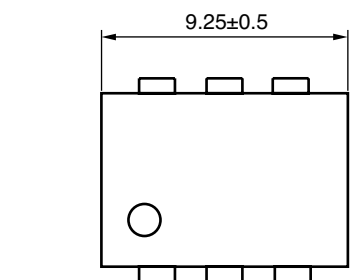

TOP VIEW

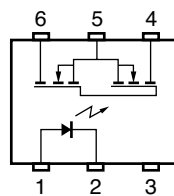

- 1. LED Anode
- 2. LED Cathode
- 3. NC
- 4. MOS FET Drain
- 5. MOS FET Source
- 6. MOS FET Drain

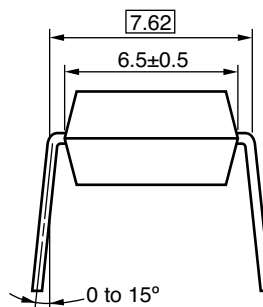
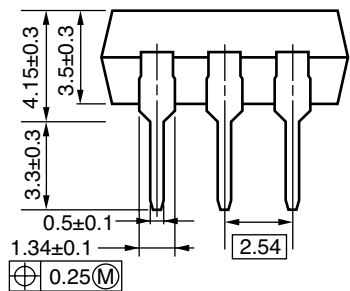

PS7142L-1A

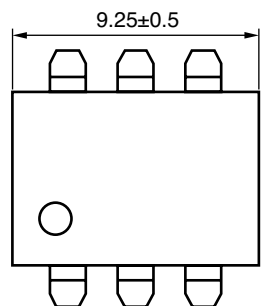

TOP VIEW

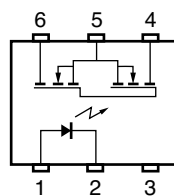

- 1. LED Anode
- 2. LED Cathode
- 3. NC
- 4. MOS FET Drain
- 5. MOS FET Source
- 6. MOS FET Drain

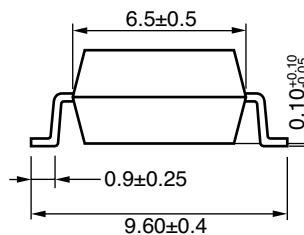
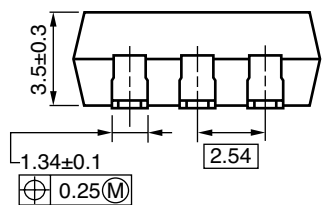

ORDERING INFORMATION

| PART NUMBER | PACKAGE | PACKING STYLE | APPLICATION PART NUMBER *1 |
|---------------|-----------|-----------------------------|----------------------------|
| PS7142-1A | 6-pin DIP | Magazine case 50 pcs | PS7142-1A |
| PS7142L-1A | | | PS7142L-1A |
| PS7142L-1A-E3 | | Embossed Tape 1000 pcs/reel | |
| PS7142L-1A-E4 | | | |

*1 For the application of the Safety Standard, following part number should be used.

ABSOLUTE MAXIMUM RATINGS ($T_A = 25^\circ\text{C}$, unless otherwise Specified)

| PARAMETER | | SYMBOL | RATINGS | UNIT | |
|-------------------------------|---|--------------|-------------|------------------|----|
| Diode | Forward Current (DC) | I_F | 50 | mA | |
| | Reverse Voltage | V_R | 5.0 | V | |
| | Power Dissipation | P_D | 50 | mW | |
| | Peak Forward Current *1 | I_{FP} | 1 | A | |
| MOS FET | Break Down Voltage | V_L | 400 | V | |
| | Continuous Load Current *2 | Connection A | I_L | 200 | mA |
| | | Connection B | | 250 | |
| | | Connection C | | 400 | |
| | Pulse Load Current *3 (AC/DC Connection) | I_{LP} | 400 | mA | |
| Power Dissipation | P_D | 560 | mW | | |
| Isolation Voltage *4 | | BV | 1 500 | Vr.m.s. | |
| Total Power Dissipation | | P_T | 610 | mW | |
| Operating Ambient Temperature | | T_A | -40 to +85 | $^\circ\text{C}$ | |
| Storage Temperature | | T_{stg} | -40 to +100 | $^\circ\text{C}$ | |

*1 $PW = 100 \mu\text{s}$, Duty Cycle = 1 %

*2 Conditions: $I_F \geq 2 \text{ mA}$. The following types of load connections are available.

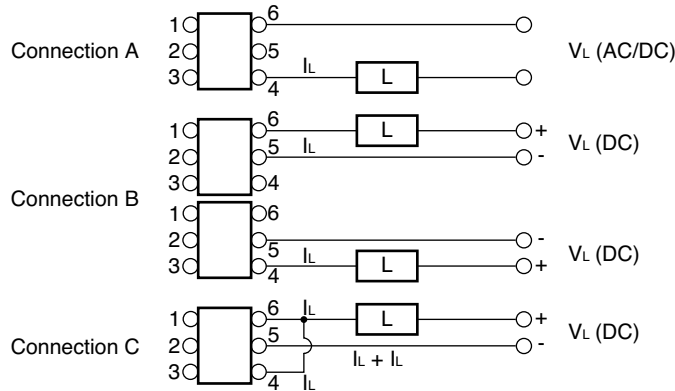

*3 $PW = 100 \text{ ms}$, 1 shot

*4 AC voltage for 1 minute at $T_A = 25 \text{ }^\circ\text{C}$, RH = 60 % between input and output

RECOMMENDED OPERATING CONDITIONS ($T_A = 25^\circ\text{C}$)

| PARAMETER | SYMBOL | MIN. | TYP. | MAX. | UNIT |
|-----------------------|--------|------|------|------|------|
| LED Operating Current | I_F | 2 | 10 | 20 | mA |
| LED Off Voltage | V_F | 0 | | 0.5 | V |

ELECTRICAL CHARACTERISTICS ($T_A = 25^\circ\text{C}$)

| PARAMETER | SYMBOL | CONDITIONS | MIN. | TYP. | MAX. | UNIT |
|-----------------------|--|--|--------|------|------|---------------|
| Diode | Forward Voltage | V_F $I_F = 10\text{ mA}$ | | 1.2 | 1.4 | V |
| | Reverse Current | I_R $V_R = 5\text{ V}$ | | | 5.0 | μA |
| MOS FET | Off-state Leakage Current | I_{Loff} $V_D = 400\text{ V}$ | | 0.03 | 1.0 | μA |
| | Output Capacitance | C_{out} $V_D = 0\text{ V}, f = 1\text{ MHz}$ | | 225 | | pF |
| Coupled | LED On-state Current | I_{Fon} $I_L = 200\text{ mA}$ | | | 2.0 | mA |
| | On-state Resistance | R_{on1} $I_F = 10\text{ mA}, I_L = 10\text{ mA}$ | | 6.0 | 10 | Ω |
| | | R_{on2} $I_F = 10\text{ mA}, I_L = 200\text{ mA}, t \leq 10\text{ ms}$ | | | | |
| | Turn-on Time *1 | t_{on} $I_F = 10\text{ mA}, V_O = 5\text{ V}, R_L = 500\ \Omega,$ | | 0.8 | 5.0 | ms |
| | Turn-off Time *1 | t_{off} $PW \geq 10\text{ ms}$ | | 0.02 | 0.2 | |
| | Isolation Resistance | $R_{\text{I-O}}$ $V_{\text{I-O}} = 1.0\text{ kV}_{\text{DC}}$ | 10^9 | | | Ω |
| Isolation Capacitance | $C_{\text{I-O}}$ $V = 0\text{ V}, f = 1\text{ MHz}$ | | 1.1 | | pF | |

*1 Test Circuit for Switching Time

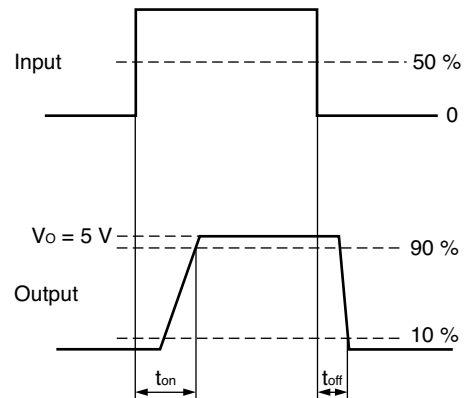
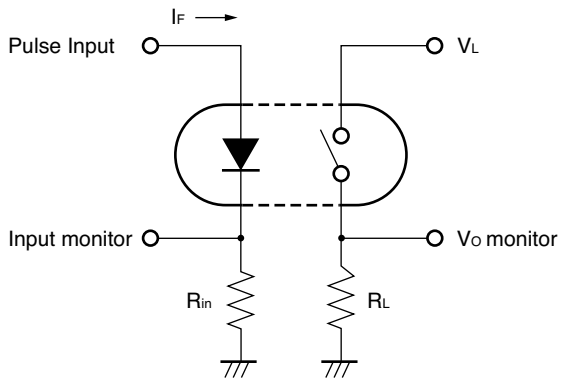

TYPICAL CHARACTERISTICS ($T_A = 25^\circ\text{C}$, unless otherwise specified)

MAXIMUM FORWARD CURRENT vs. AMBIENT TEMPERATURE

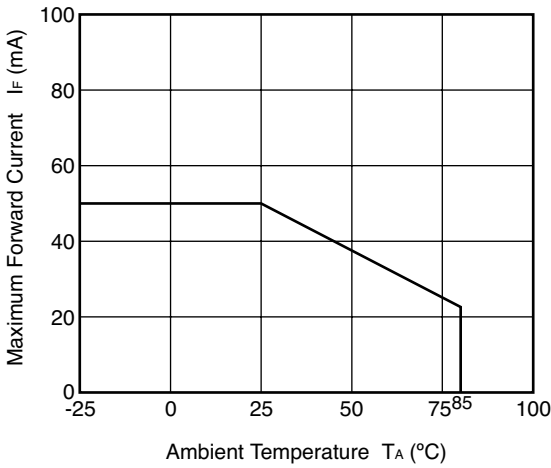

MAXIMUM LOAD CURRENT vs. AMBIENT TEMPERATURE

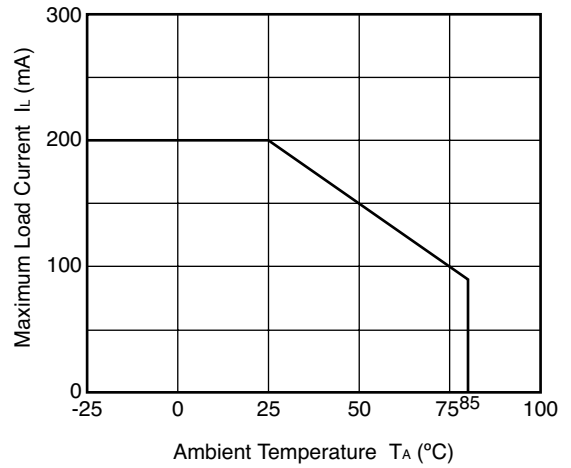

FORWARD VOLTAGE vs. AMBIENT TEMPERATURE

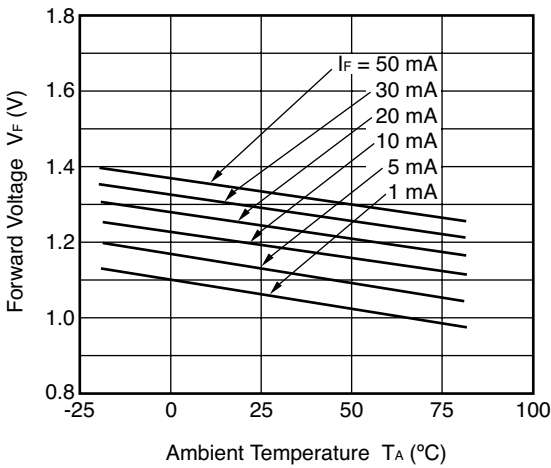

OUTPUT CAPACITANCE vs. APPLIED VOLTAGE

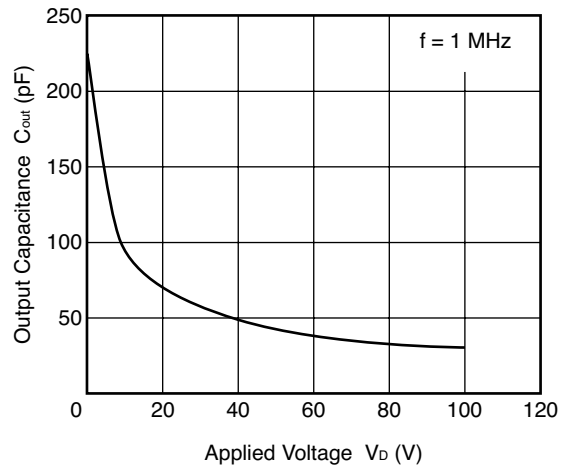

OFF-STATE LEAKAGE CURRENT vs. APPLIED VOLTAGE

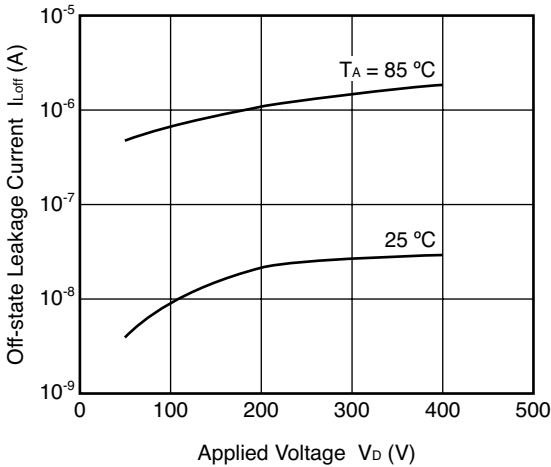

LORD CURRENT vs. LORD VOLTAGE

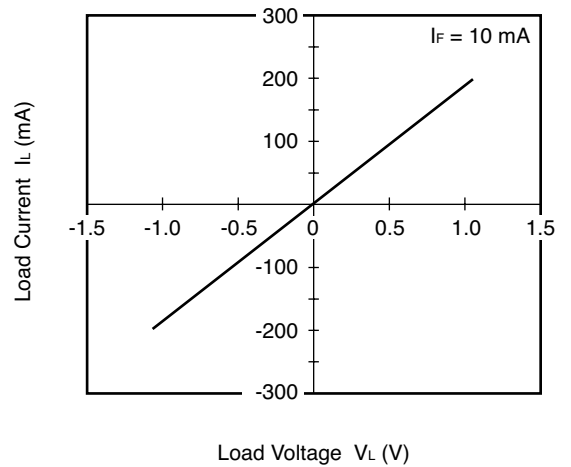

NORMALIZED ON-STATE RESISTANCE vs. AMBIENT TEMPERATURE

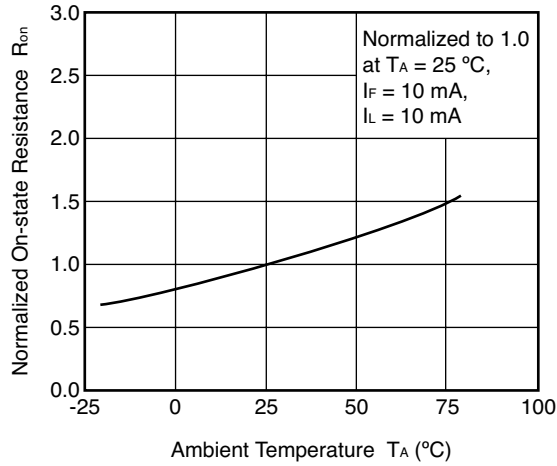

ON-STATE RESISTANCE DISTRIBUTION

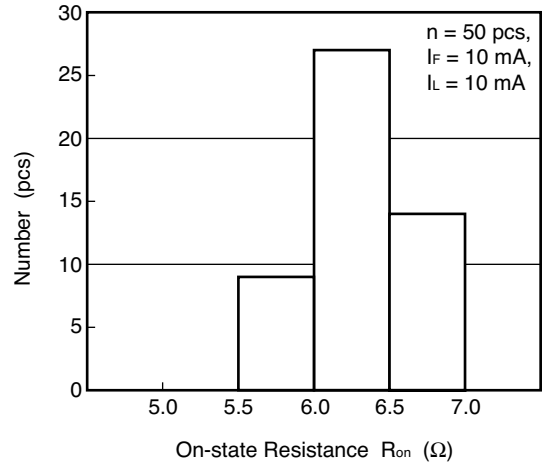

TURN-ON TIME vs. FORWARD CURRENT

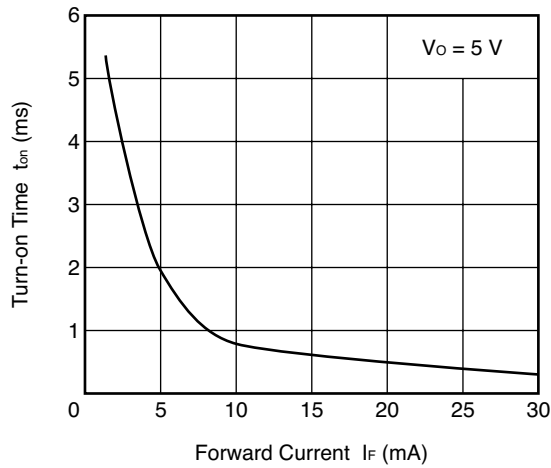

TURN-OFF TIME vs. FORWARD CURRENT

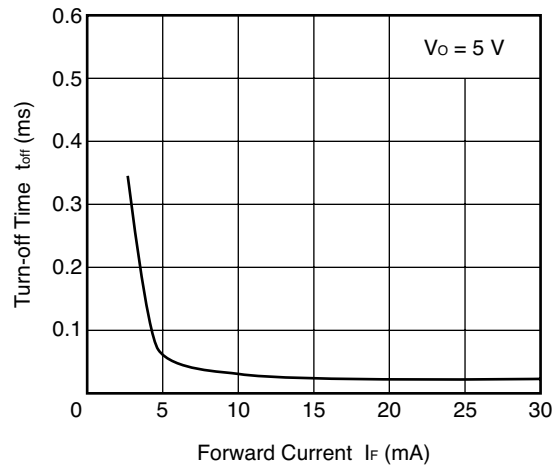

TURN-ON TIME DISTRIBUTION

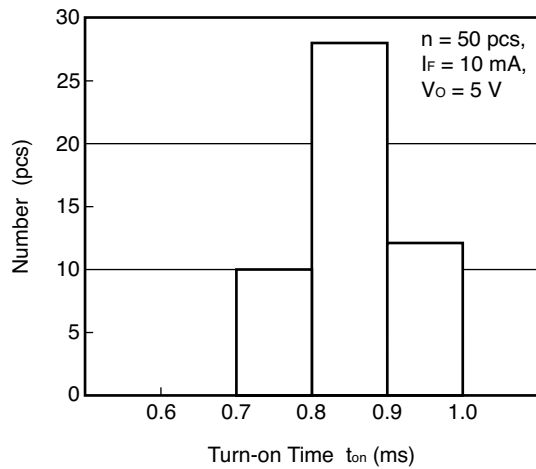

TURN-OFF TIME DISTRIBUTION

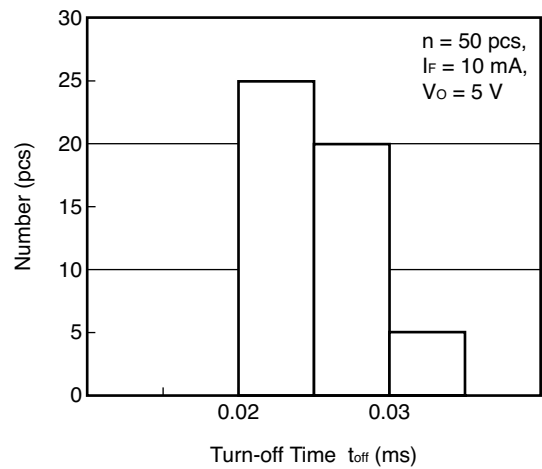

NORMALIZED TURN-ON TIME vs. AMBIENT TEMPERATURE

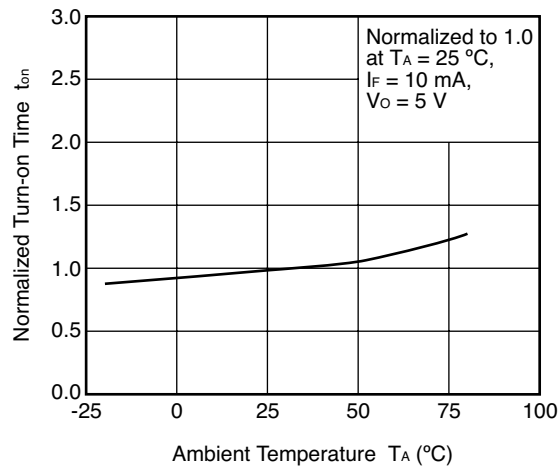

NORMALIZED TURN-OFF TIME vs. AMBIENT TEMPERATURE

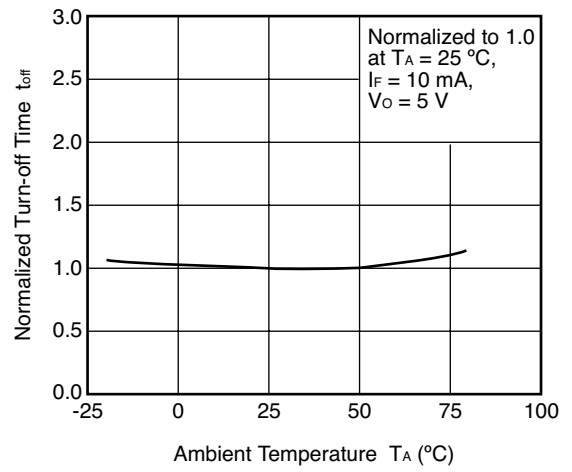

Remark The graphs indicate nominal characteristics.

TAPING SPECIFICATIONS (UNIT:mm)

Outline and Dimensions (Tape)

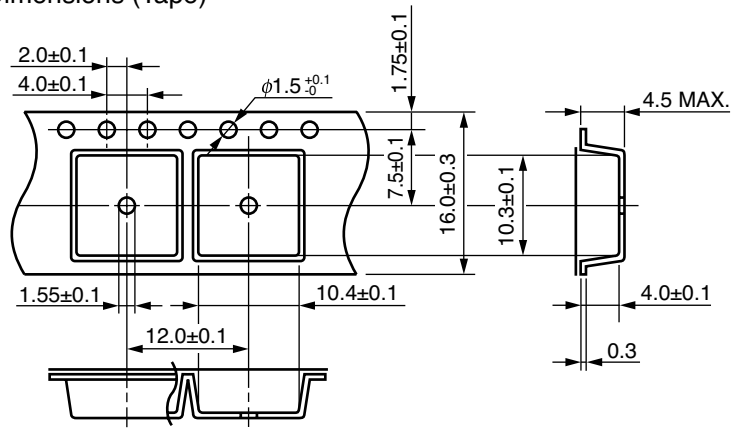

Tape Direction

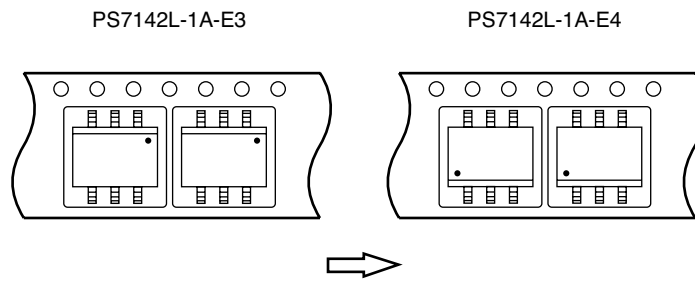

Outline and Dimensions (Reel)

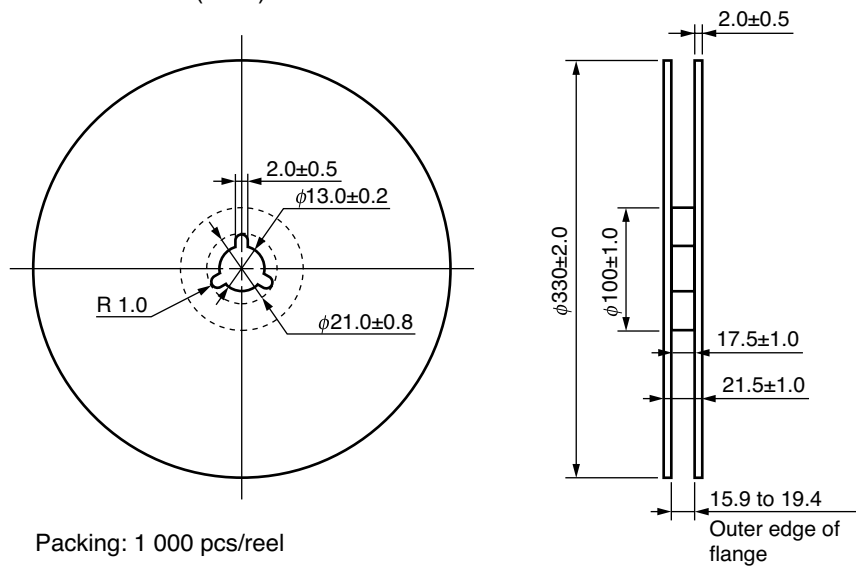

Packing: 1 000 pcs/reel

RECOMMENDED SOLDERING CONDITIONS

(1) Infrared reflow soldering

- Peak reflow temperature 260°C or below (package surface temperature)
- Time of peak reflow temperature 10 seconds or less
- Time of temperature higher than 220°C 60 seconds or less
- Time to preheat temperature from 120 to 180°C 120±30 s
- Number of reflows Three
- Flux Rosin flux containing small amount of chlorine (The flux with a maximum chlorine content of 0.2 Wt% is recommended.)

Recommended Temperature Profile of Infrared Reflow

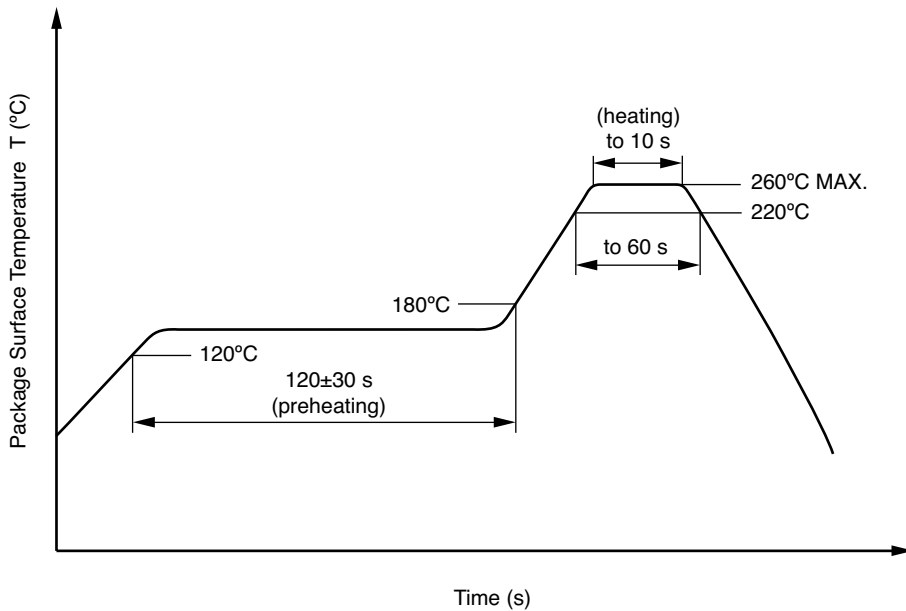

(2) Wave soldering

- Temperature 260°C or below (molten solder temperature)
- Time 10 seconds or less
- Preheating conditions 120°C or below (package surface temperature)
- Number of times One
- Flux Rosin flux containing small amount of chlorine (The flux with a maximum chlorine content of 0.2 Wt% is recommended.)

(3) Cautions

- Fluxes Avoid removing the residual flux with freon-based and chlorine-based cleaning solvent.

Life Support Applications

These NEC products are not intended for use in life support devices, appliances, or systems where the malfunction of these products can reasonably be expected to result in personal injury. The customers of CEL using or selling these products for use in such applications do so at their own risk and agree to fully indemnify CEL for all damages resulting from such improper use or sale.